

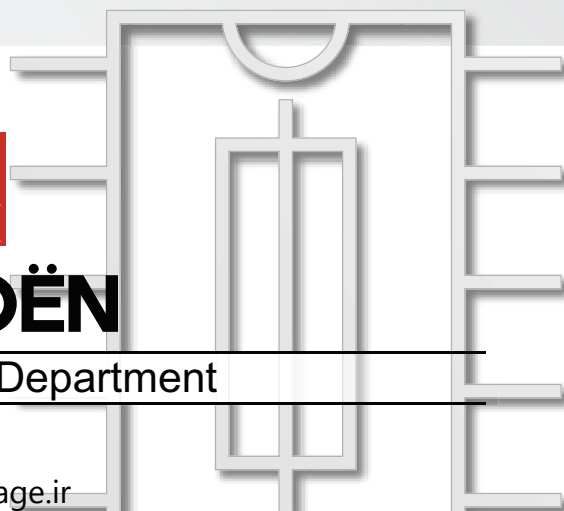

MULTIPLEX LAYOUT C5 (X7)

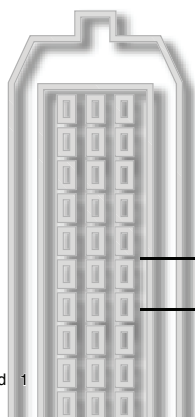
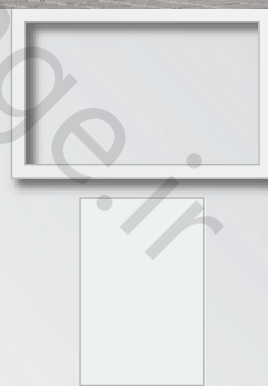
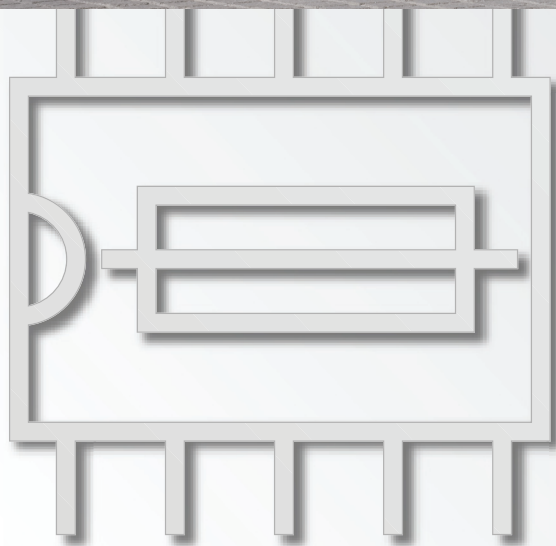

CITROËN

Citroën Training Department



www.CarGarage.ir



■ Contents

Multiplex layout	Page 2
General network layout	Page 4
Details of the intersystems HS CAN	Page 6
Layout of the intersystems HS CAN	Page 8
Details of the COMFORT LS CAN	Page 12
Layout of the COMFORT LS CAN	Page 14
Details of the BODY LS CAN	Page 17
Layout of the BODY LS CAN	Page 18
Details of the LIN	Page 20
Details of the diagnostics network	Page 27
Various stages of multiplex networks	Page 28
Wiring diagram	Page 32
Glossary	Page 35

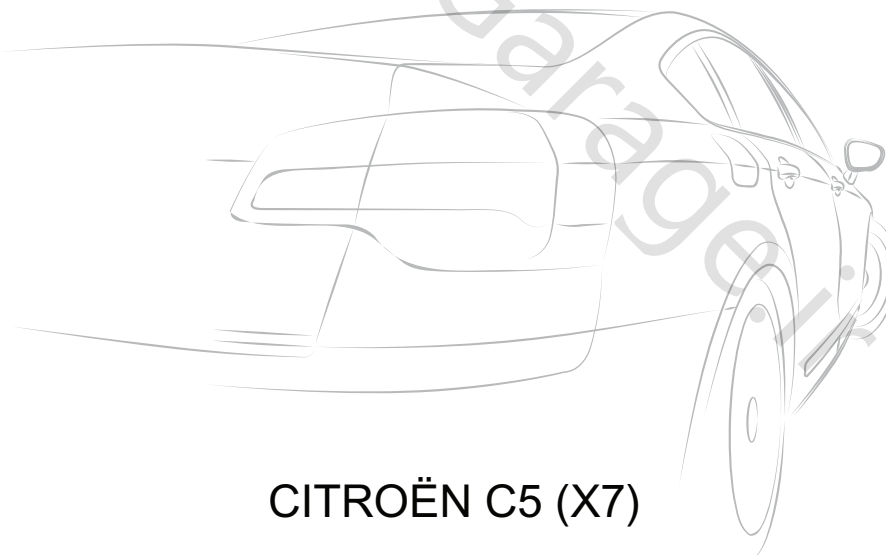

CITROËN C5 (X7)



■ Foreword

Note:

- All of the variants and values given in this document are for information only (but which are subject to change) and will not be updated.

- To see the values for the vehicle, you must refer to the technical after-sales documentation.



▪ Multiplex layout

▪ Networks:

The vehicle is FULL CAN. It has a Built-in Systems Interface (BSI) which forms the link between the networks. It centralises and processes information from the various networks.

The multiplex layout consists of:

An intersystems HS CAN: 500 Kbit/s high speed CAN connecting the BSI and the dynamic ECUs.

The intersystems HS CAN is not "Fault Tolerant", in other words it will not operate in the event of a break or short circuit on one of the two wires.

A 120 Ohm terminal line resistor is incorporated into the BSI and the engine management ECU.

A BODY LS CAN: 125 Kbit/s low speed CAN connecting the BSI and the ECUs of the bodywork network.

A COMFORT LS CAN: 125 Kbit/s low speed CAN connecting the BSI and the ECUs of the comfort network.

The BODY and COMFORT LS CANs are "Fault Tolerant", in other words they will operate in downgraded mode in the following cases:

- A wire break,
- Short circuit of one wire to supply,
- Short circuit of one wire to earth,
- Short circuit between two wires of the LS CAN.

In this case, the network becomes more sensitive to interference and may, under certain conditions, become non operational.

Several LINs: LIN with specific speed of 19.2 Kbits/s connecting:

- The BSI to the Battery Charge Status Unit (1031) as well as the seat belt reminder LED unit (4746),
- The headlamp beam correction ECU (6606) to the two headlamps,
- The lateral trajectory monitoring ECU (7550) to the six sensors,
- The switch module at the steering wheel (CV00) to the Fixed-Centred Controls Steering Wheel (VCCF),
- The engine compartment fuse and relay plate (PSF1) to the two windscreen wiper motors,
- The driver's door switch panel (6036) to the four electric window motors as well as to the passenger's door mirror lighting and memorising unit (6404).



■ Diagnostics:

The intersystems DIAG CAN (500 Kbits/s) is used to:

- Download (in several minutes) the software for ECUs on the intersystems HS CAN,
- Provide the information required for the EOBD standard (European On Board Diagnosis) allowing emissions control information to be monitored.

The DIAG ON CAN (500 Kbits/s) is used to:

- Perform diagnostics on the ECUs of the various networks,
- Download software for ECUs on the BODY CAN and COMFORT CAN, as well as the BSI,
- Configure ECUs.

The K diagnostic line (10.4 Kbits/s) is used to:

- Diagnose faults on ECUs of the intersystems HS CAN not notified by the Intersystems DIAG CAN ("scan tool" type).



General network layout

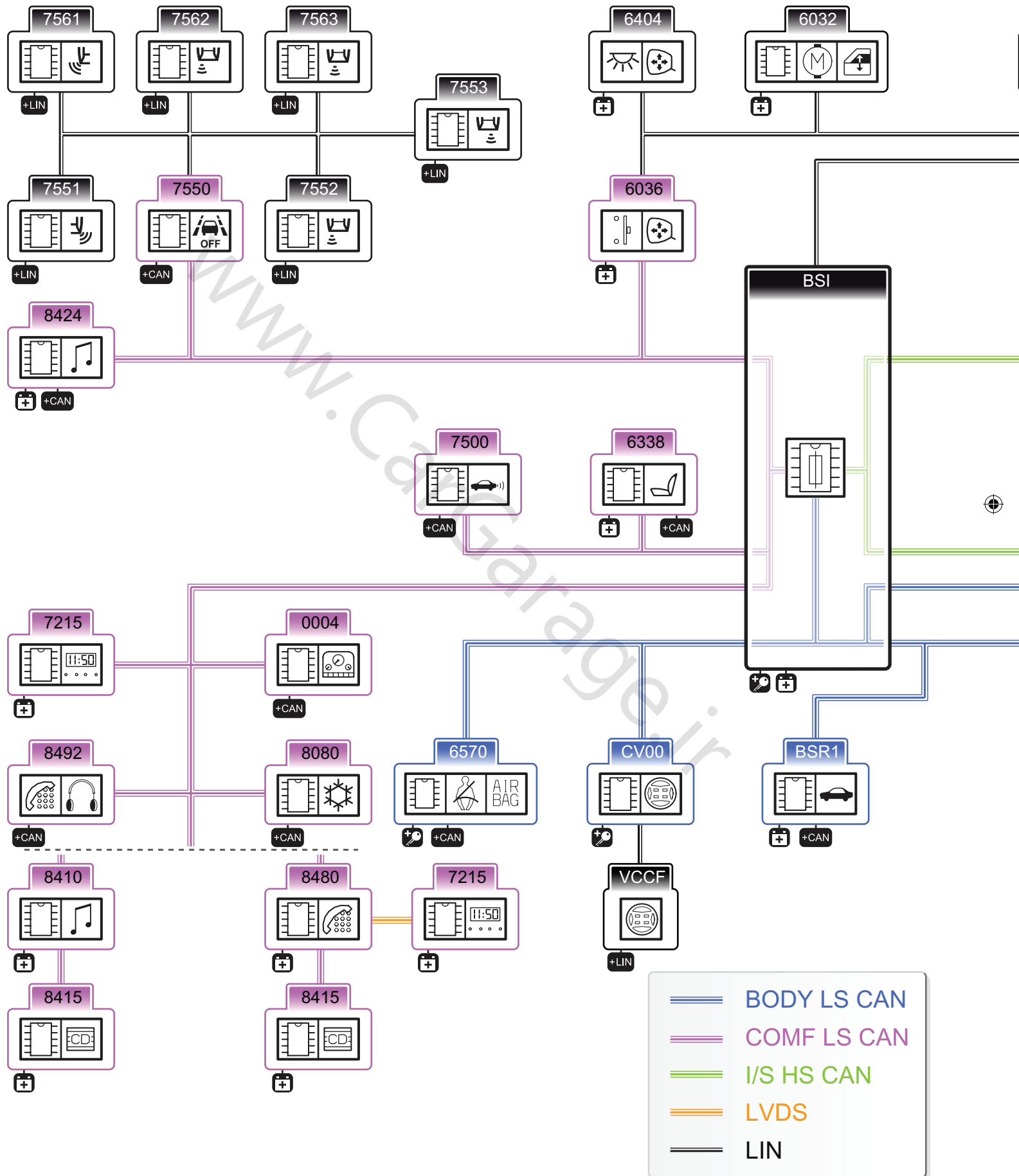

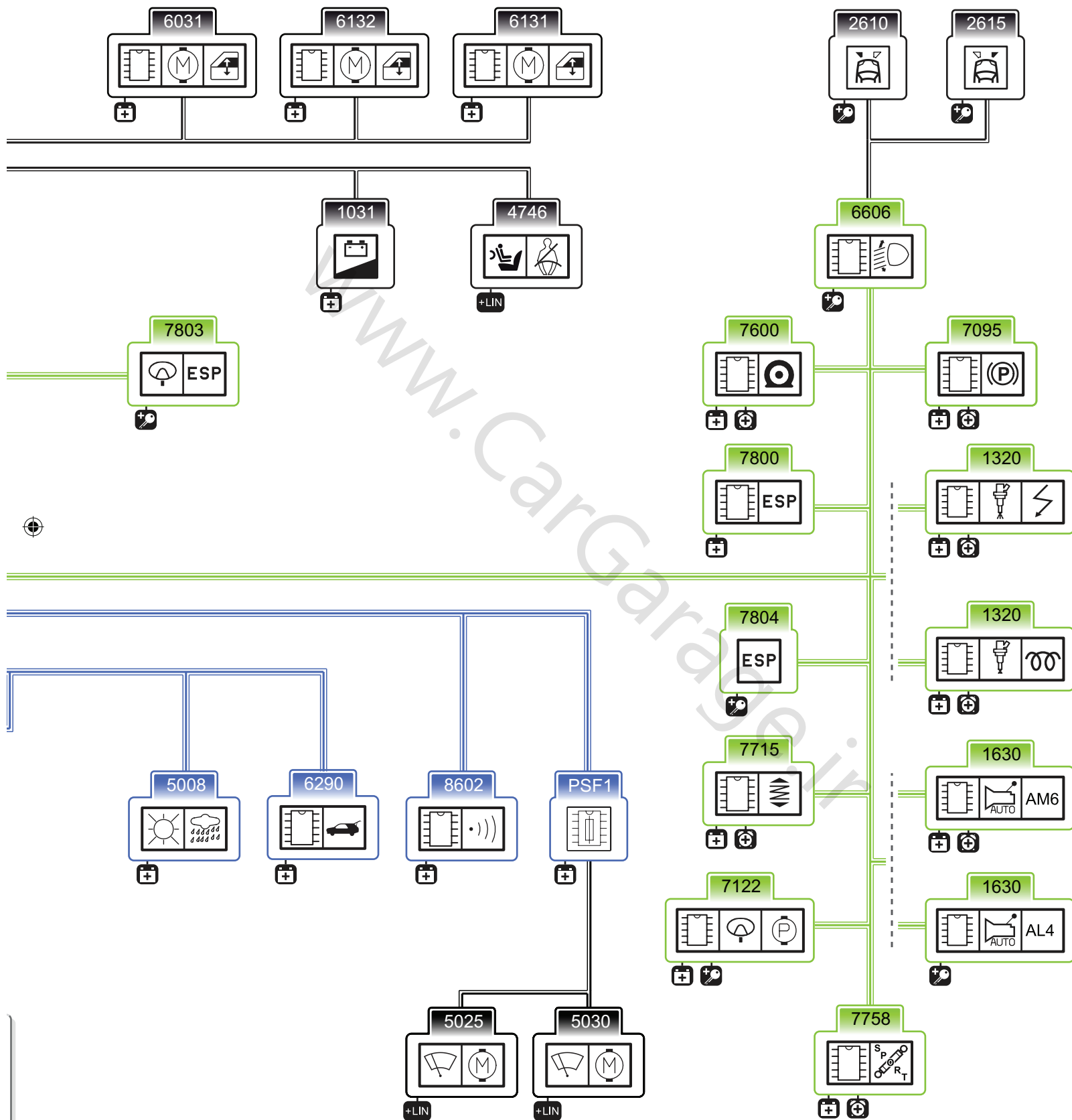



▪ Details of the intersystems HS CAN

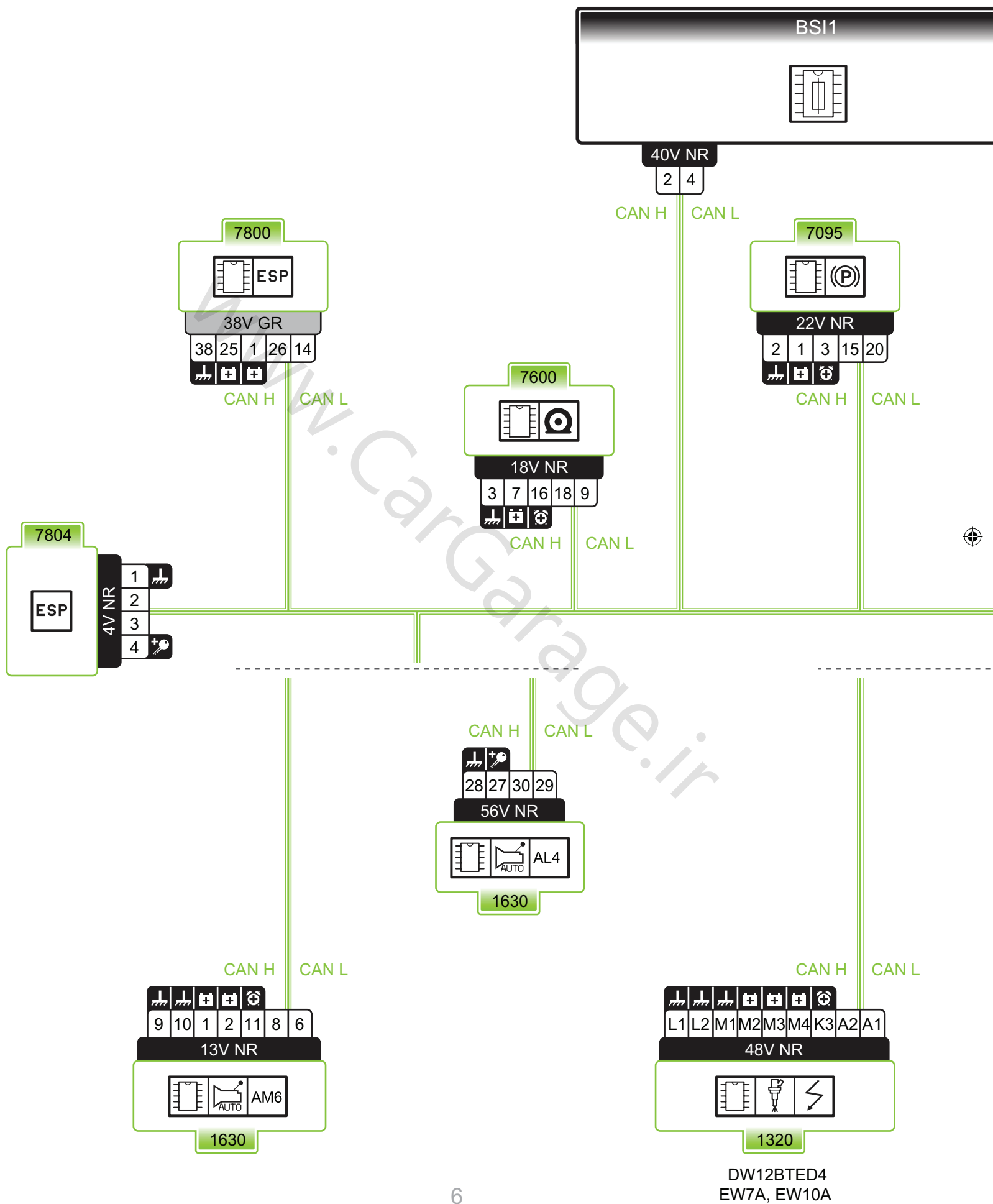

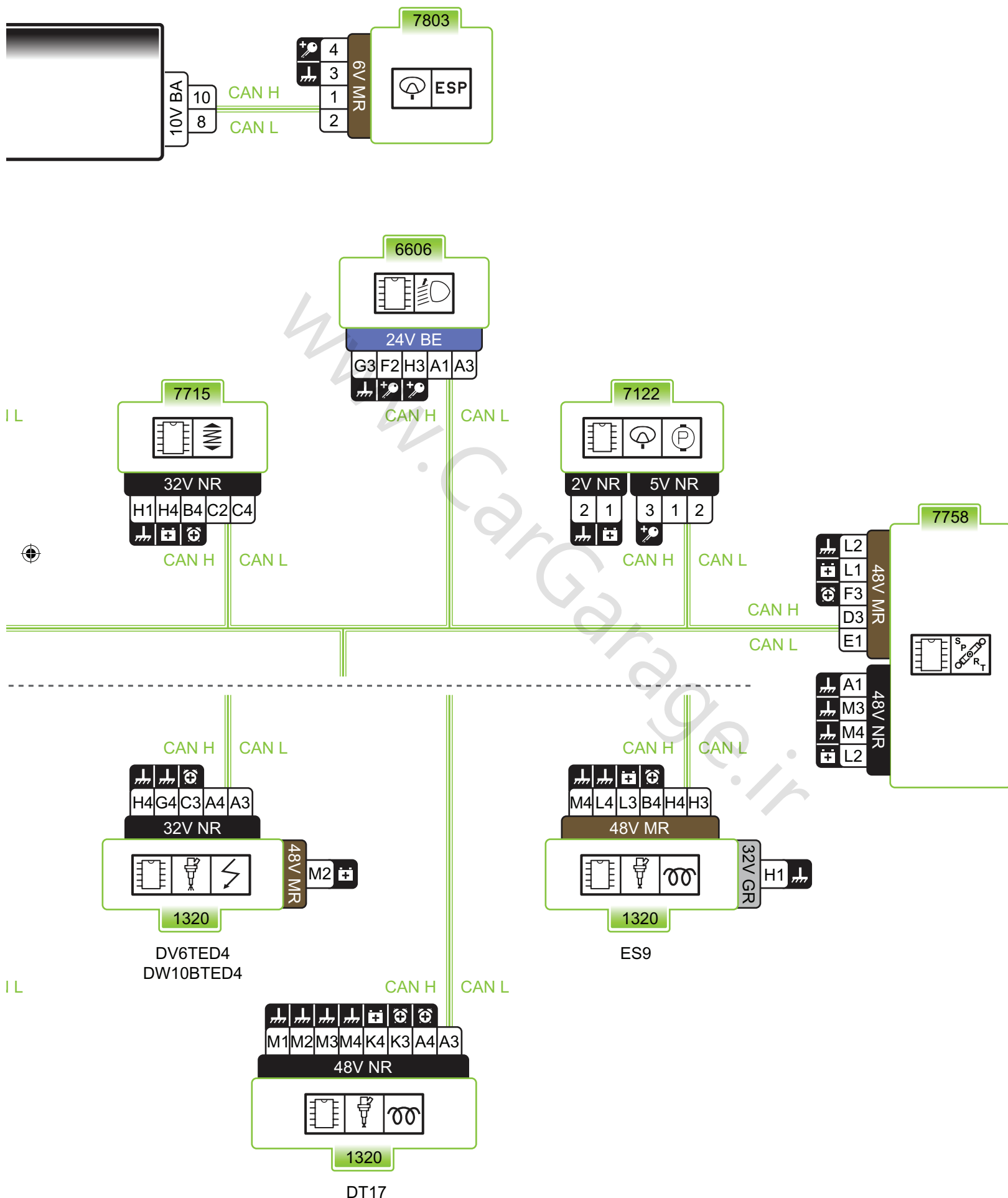

Layout of the intersystems HS CAN

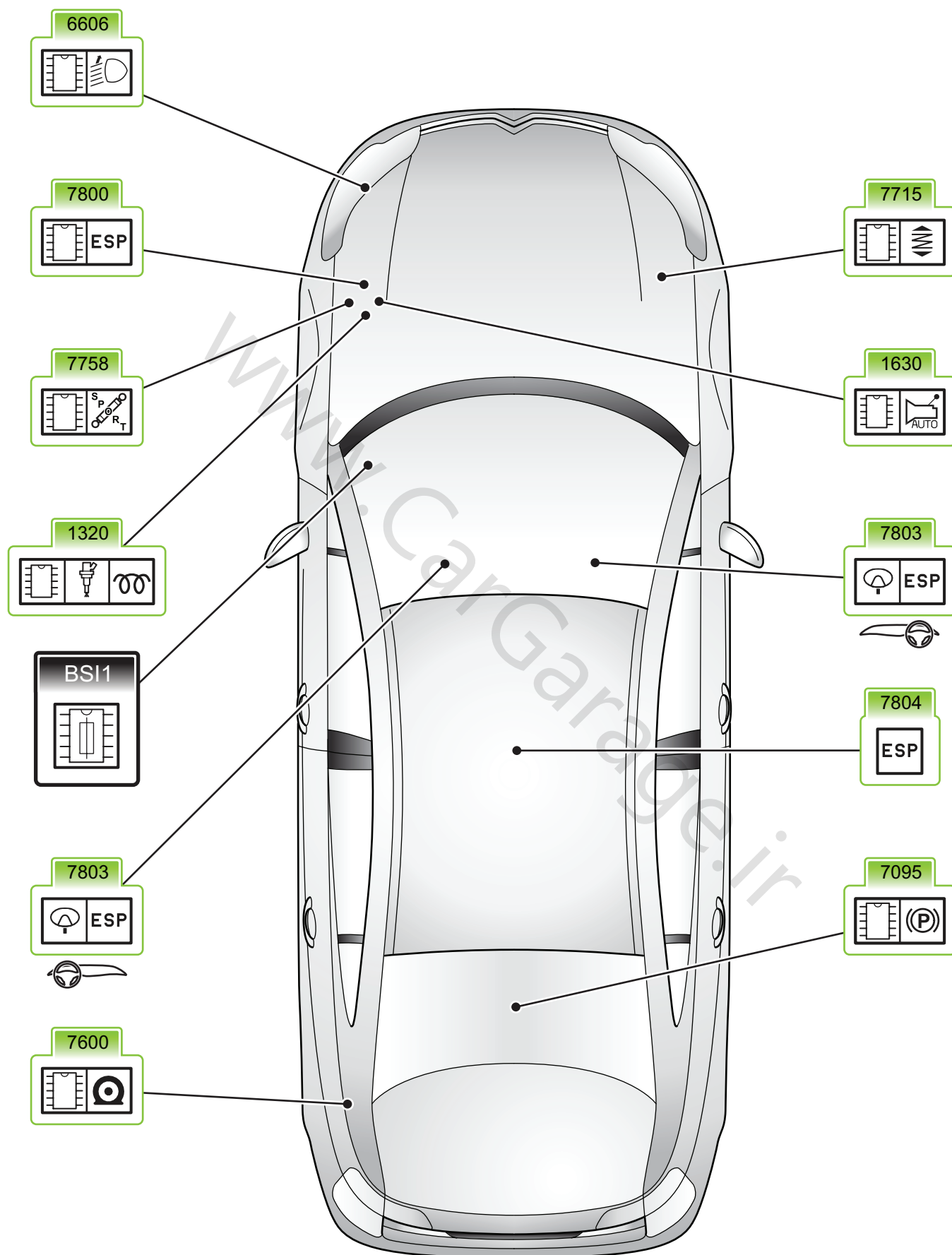

Intersystems HS CAN

		<p>Built-in Systems Interface</p>
		<p>management ECU Engine</p>
		<p>ECU Automatic gearbox</p>
		<p>correction ECU Headlamp beam</p>
		<p>brake ECU Electric parking</p>
		<p>unit ECU steering electric pump Power</p>
		<p>detection ECU Tyre deflation</p>



▪ Layout of the intersystems HS CAN

▪ Intersystems HS CAN		
		suspension ECU
		suspension ECU Variable damping
		control ECU Traction
		ESP steering wheel angle sensor
		gyrometer triple sensor ESP accelerometer



▪ Notes

Lined area for notes with a diagonal watermark reading 'www.CarGarage.ir'.

Details of the COMFORT LS CAN

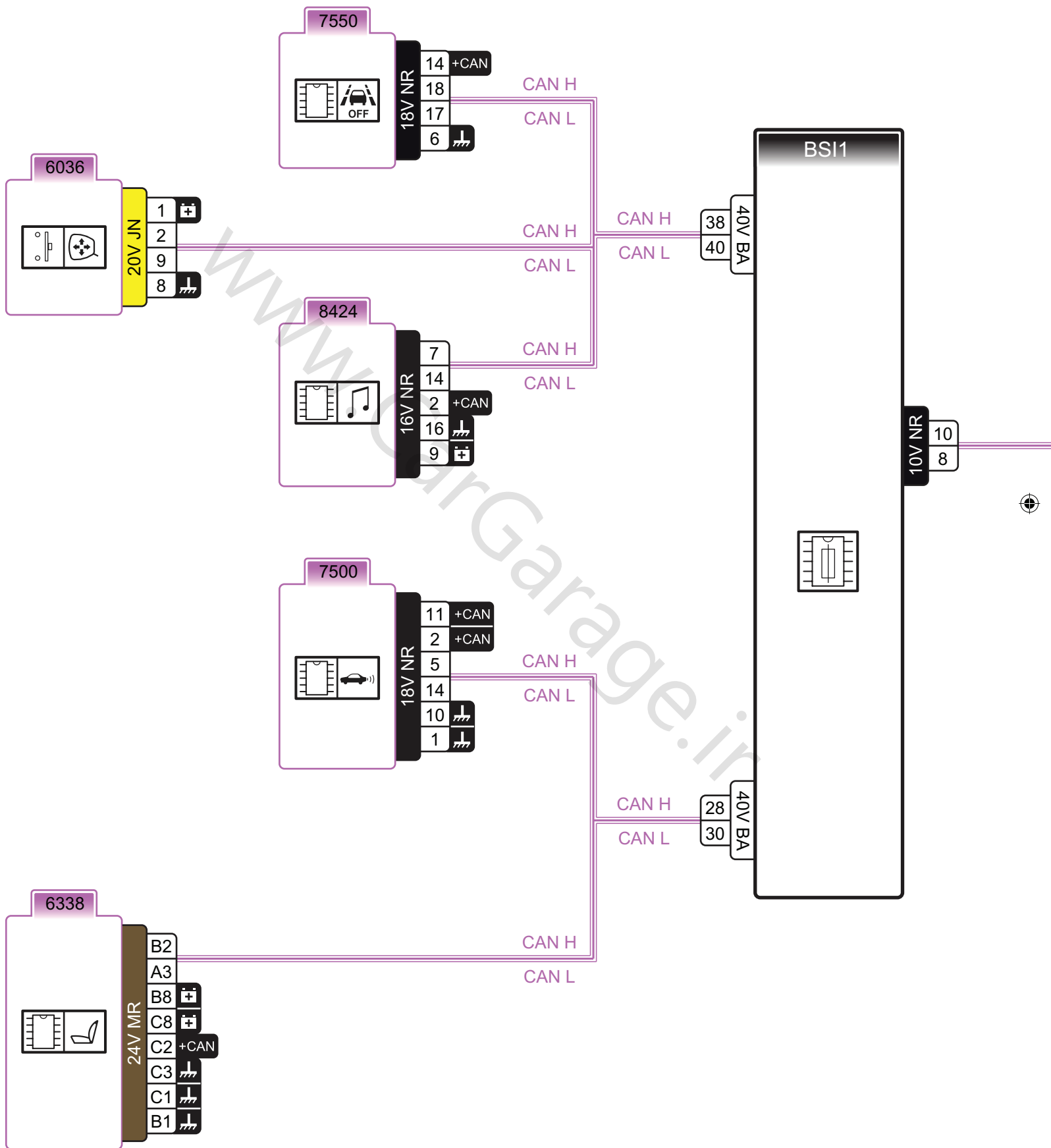

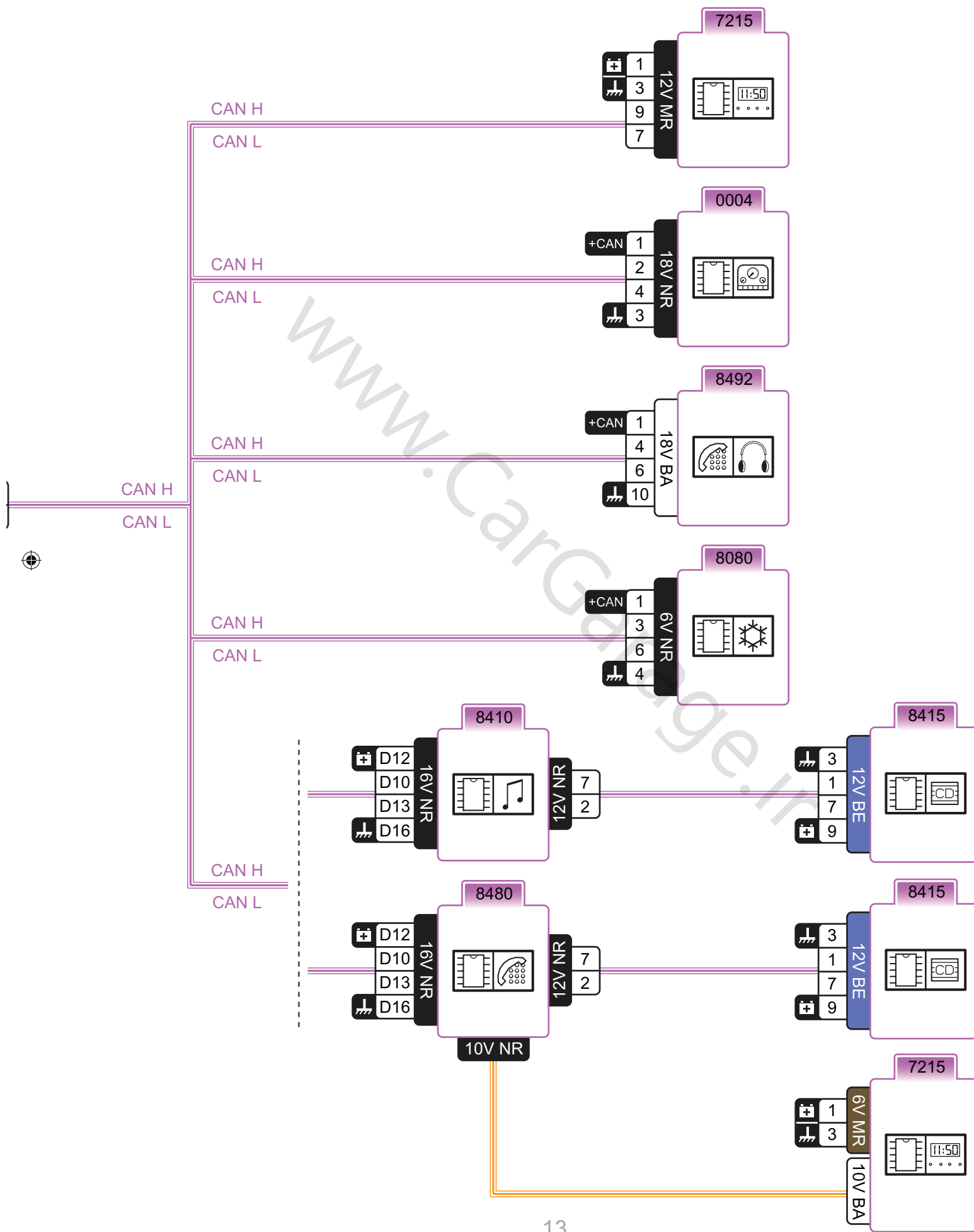



Layout of the COMFORT LS CAN

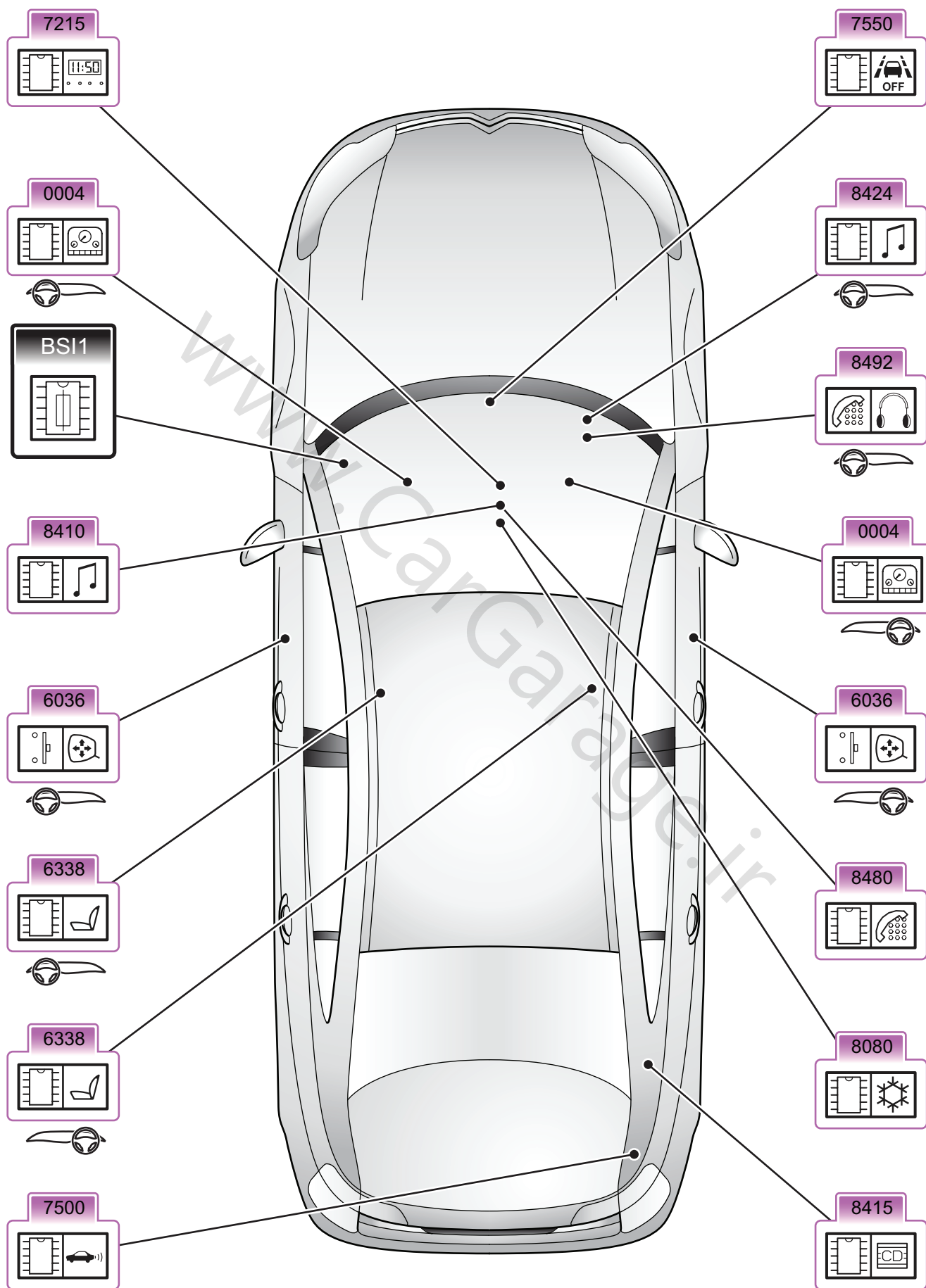









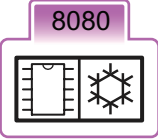

COMFORT LS CAN

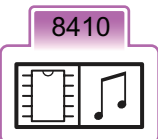
		<p>Built-in Systems Interface</p>
		<p>Control panel</p>
		<p>Driver's door switch panel</p>
		<p>Seat memorising unit</p>
		<p>Multifunction display (monochrome or colour)</p>
		<p>assistance ECU Parking (front and rear)</p>
		<p>monitoring ECU Lateral trajectory</p>

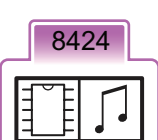

▪ Layout of the COMFORT LS CAN

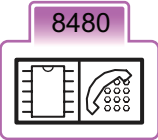
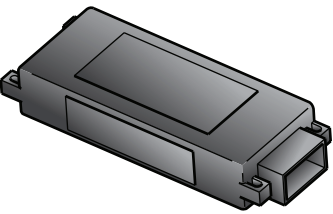
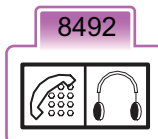
▪ COMFORT LS CAN		
		ECU Air conditioning (mono or dual zone panel)
		Radio
		CD changer
		Audio amplifier
		receiver transmitter Telematic (RT4)
		Hands free kit "Bluetooth"

▪ Details of the BODY LS CAN

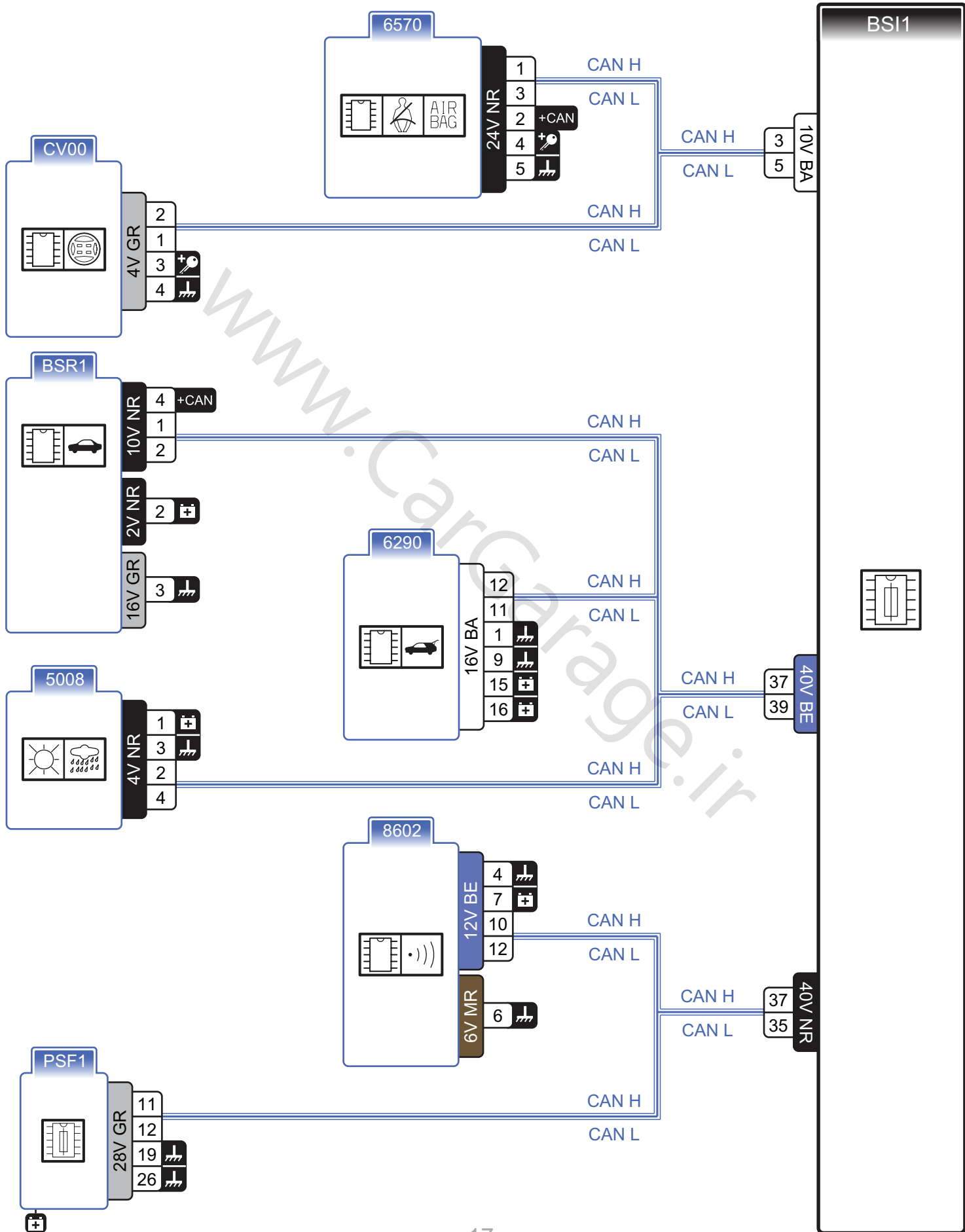



Layout of the BODY LS CAN

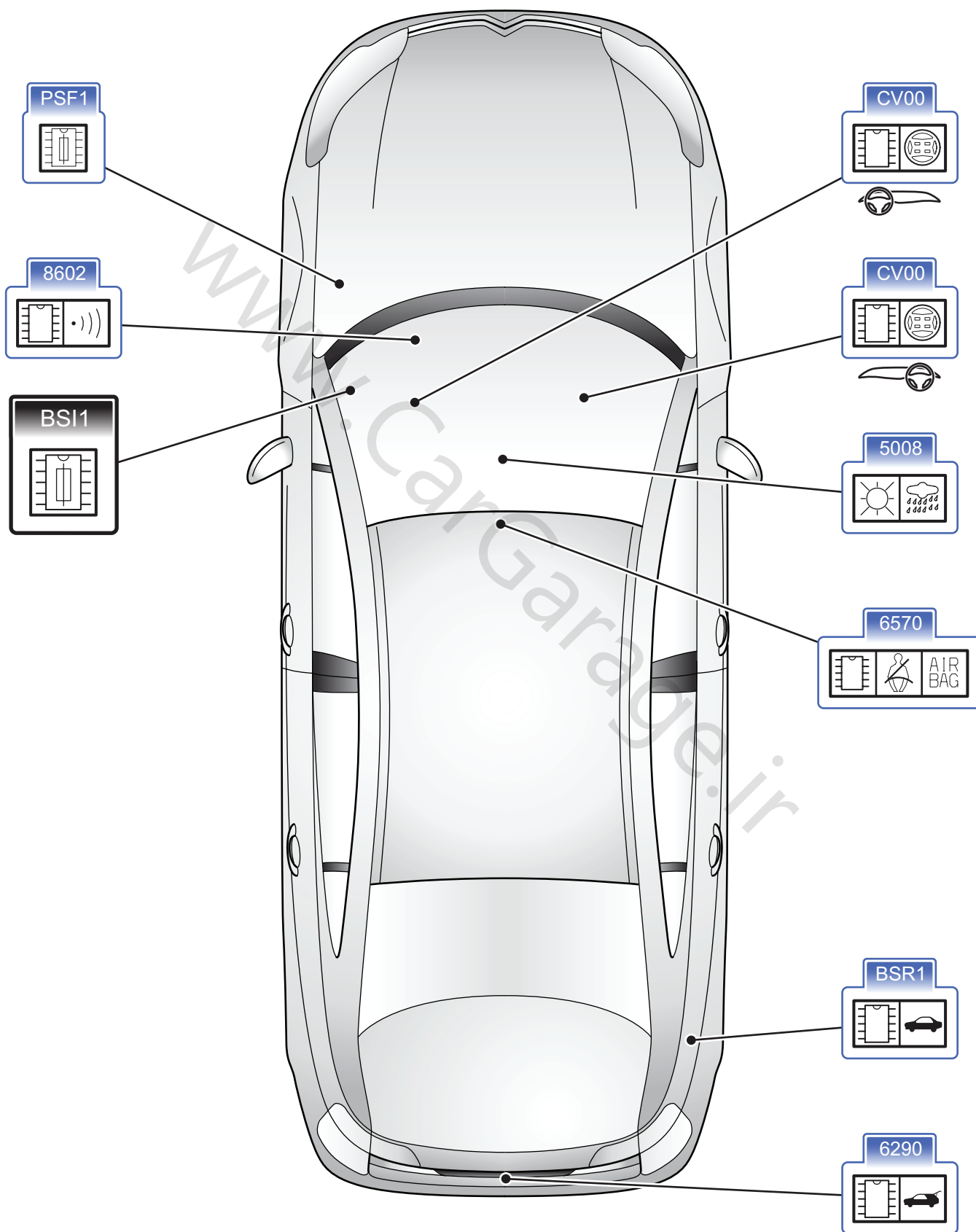



■ BODY LS CAN

	 <p>BS1</p>	<p>Built-in Systems Interface</p>
	 <p>BSR1</p>	<p>relay unit Trailer</p>
	 <p>CV00</p>	<p>Switch module at the steering wheel</p>
	 <p>PSF1</p>	<p>and relay unit compartment fuse Engine</p>
	 <p>5008</p>	<p>and rain sensor Brightness</p>
	 <p>6290</p>	<p>boot ECU Motorised</p>
	 <p>6570</p>	<p>Airbag ECU</p>
	 <p>8602</p>	<p>Alarm unit</p>



▪ Details of the LIN

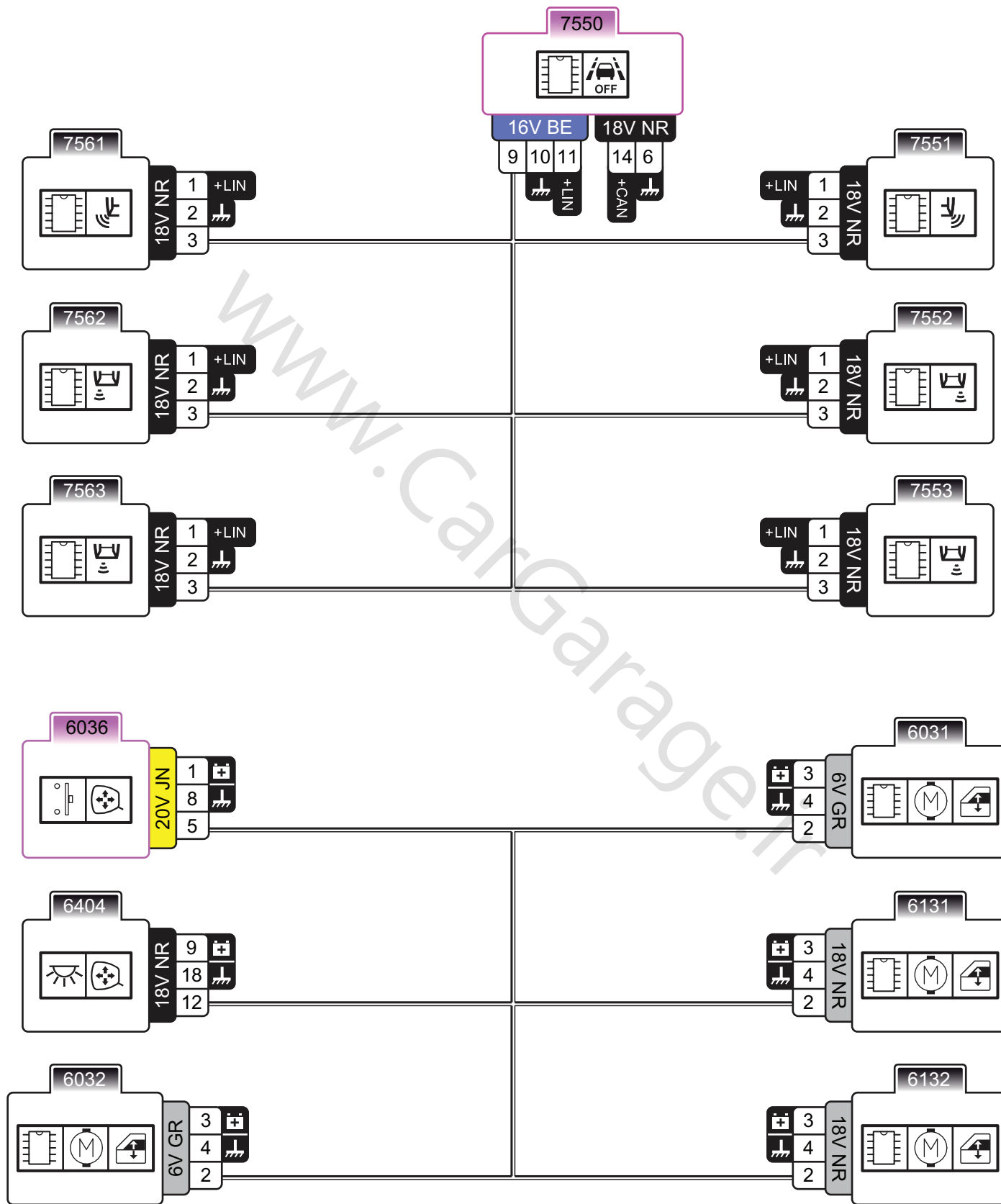

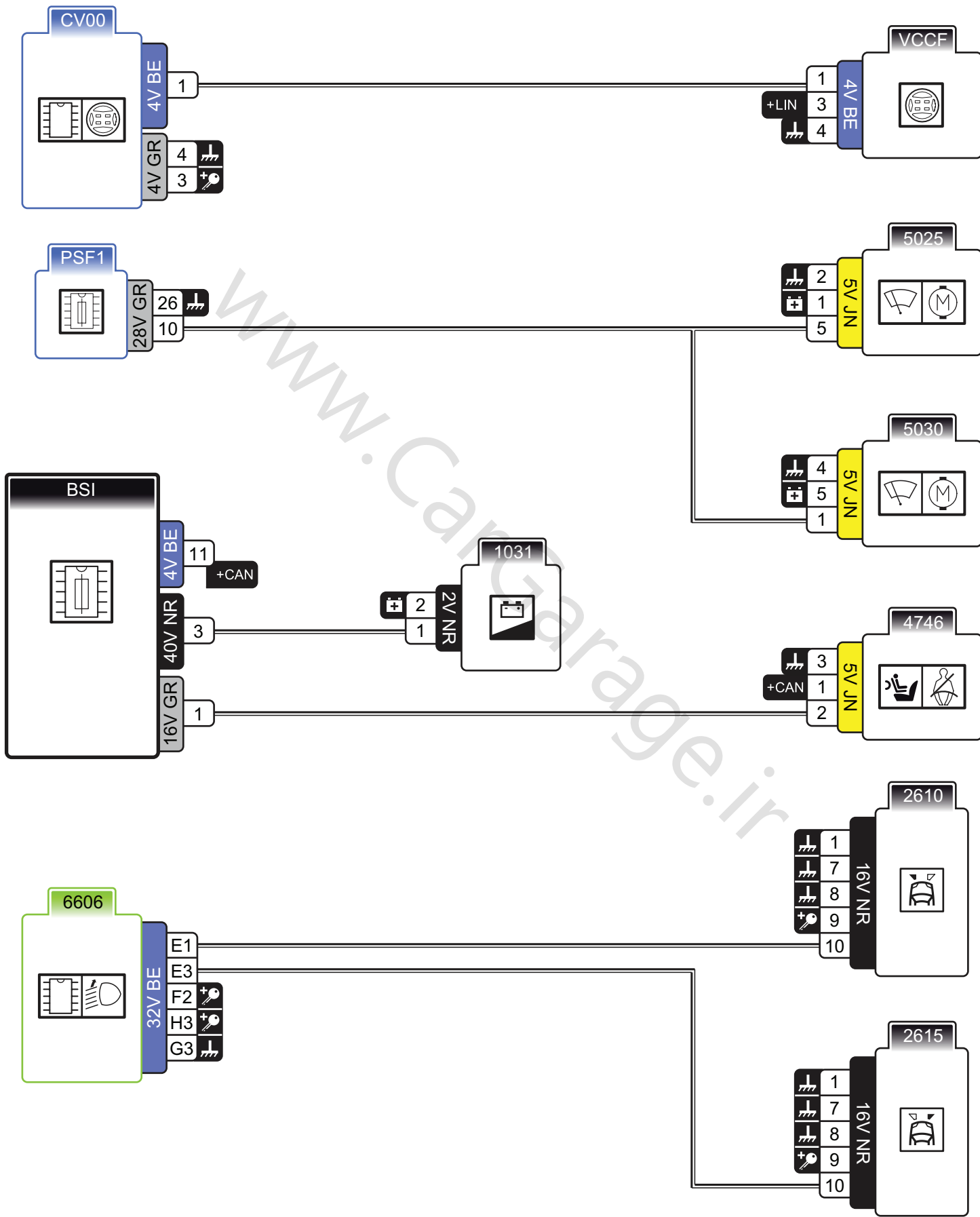





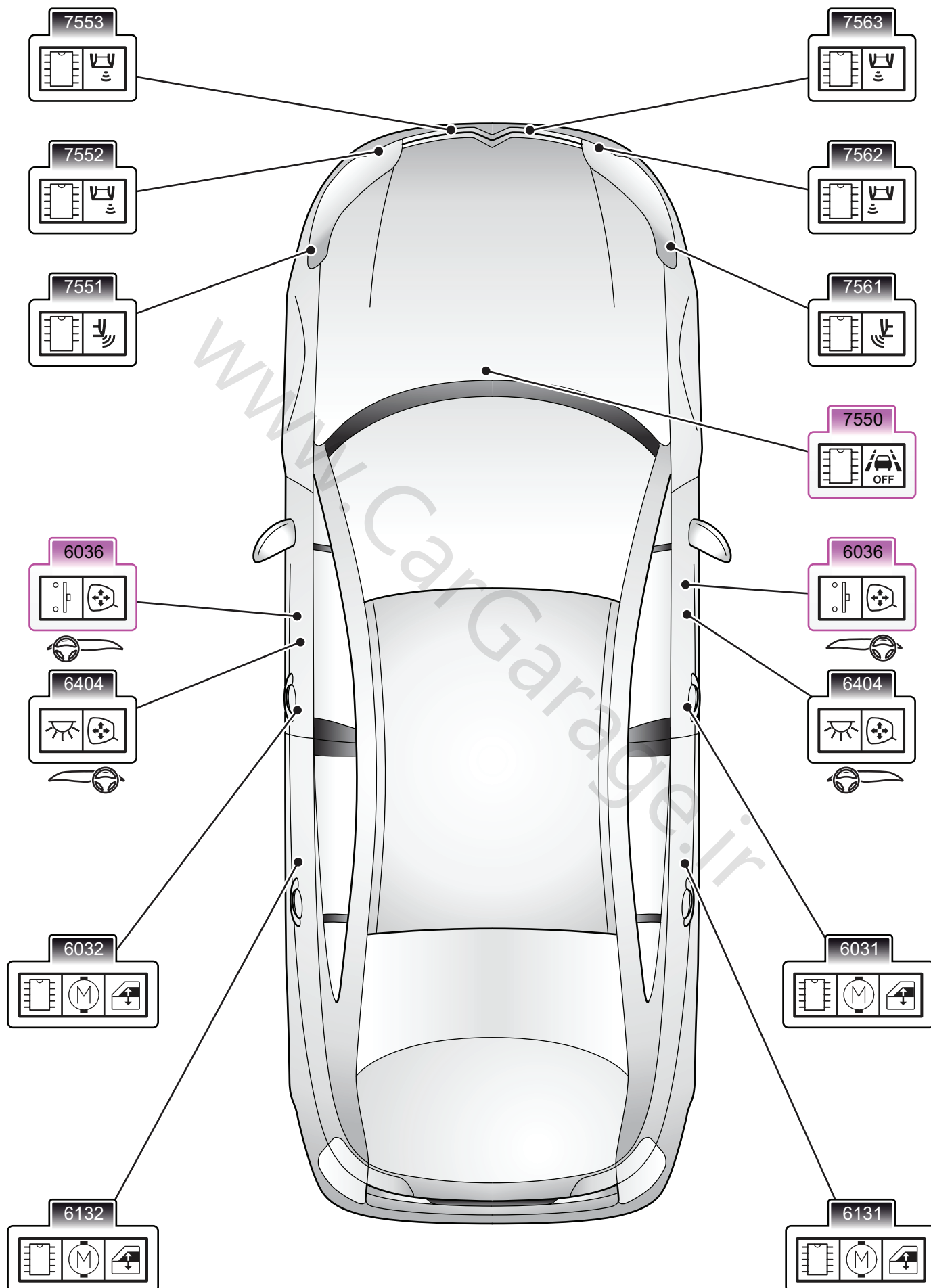



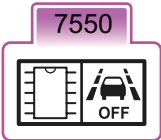

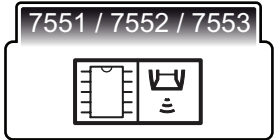

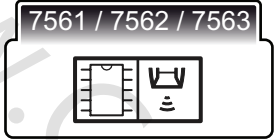
Layout of the LIN



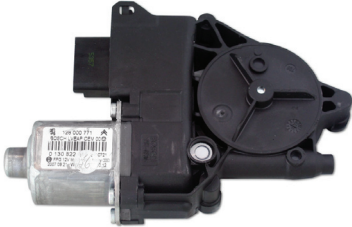

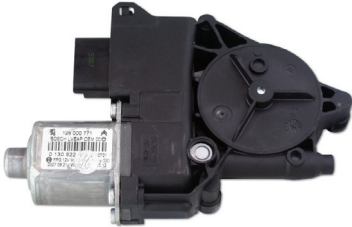
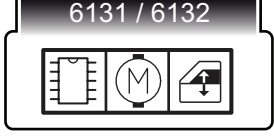
LIN		
		monitoring ECU Lateral trajectory
		LH monitoring sensors Lateral trajectory
		RH monitoring sensors Lateral trajectory
		Driver's door switch panel
		Lighting and memorising unit Passenger's door mirror
		unit and motor assembly Front RH electric window (6031) and front LH (6032)
		unit and motor assembly Front RH electric window (6131) and front LH (6132)



Layout of the LIN

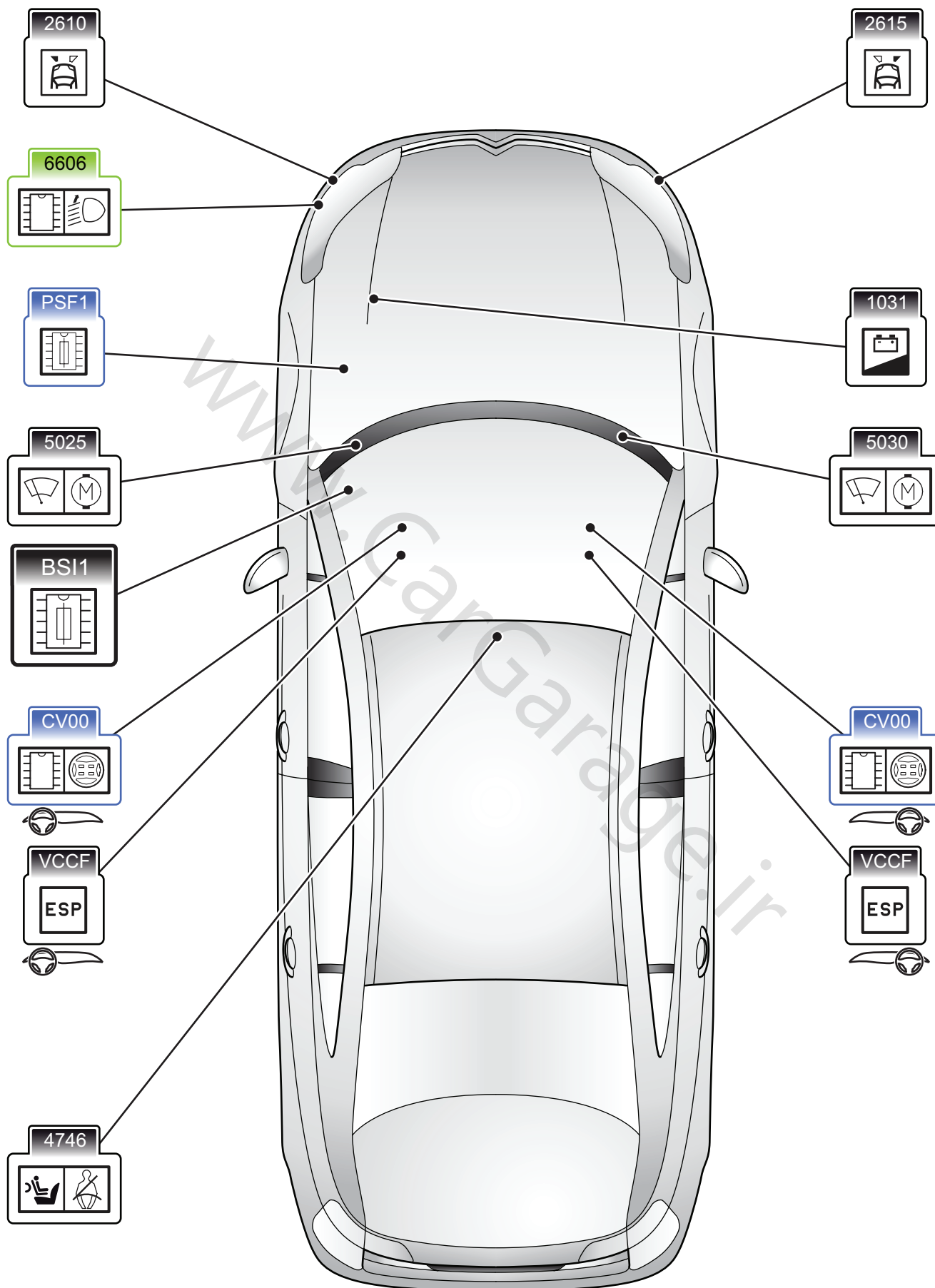

LIN

		Built-in Systems Interface
		charge status unit Battery
		reminder LED unit Seat belt
		Switch module at the steering wheel
		controls steering wheel Fixed-centred
		correction ECU Headlamp beam
		RH and LH headlamps
		and relay unit compartment fuse Engine
		and LH windscreen wiper motors RH



■ Notes

Lined area for notes with a diagonal watermark: www.CarGarage.ir

▪ Details of the diagnostics network

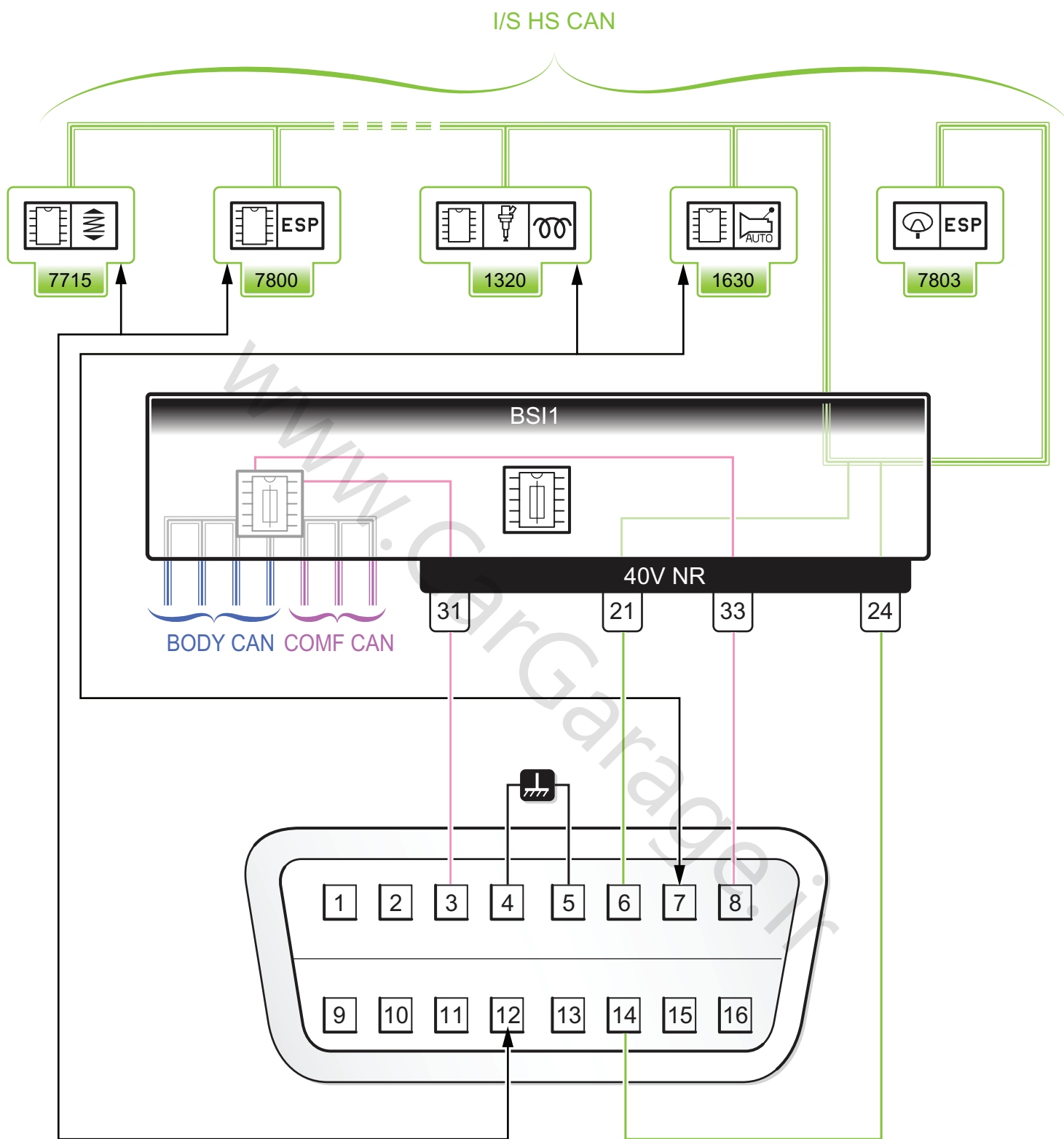

	BODY LS CAN		I/S DIAG CAN
	COMF LS CAN		DIAG ON CAN
	I/S HS CAN		I/S HS CAN



■ Various stages of multiplex networks

The BSI controls the wake-up and stand-by of the various networks.

■ Network wake-up:

CAN ECUs have two wake-up states:

Main wake-up:

In this condition, the CANs are active and all ECUs communicate with each other.

▷ Intersystems HS CAN:

When the ignition is switched on, the RCD ECUs are woken up by the BSI by permanently sending +12 Volts on the RCD line and a main wake-up frame. For the other ECUs (non RCD), the BSI or the PSF1 provides a +IGN.

▷ LS CAN:

When the ignition is switched on, the ECUs are woken up when the +CAN appears controlled by the BSI. At the same time, the BSI sends a main wake-up frame on the BODY CAN and COMFORT CAN

Partial wake-up:

This wake-up is used to communicate with certain ECUs on the CAN in order to anticipate certain operating phases.

▷ Intersystems HS CAN:

When the ignition is off, the BSI partially wakes up the RCD ECUs by sending a +12 Volts sur la ligne RCD et une trame de réveil partiel.

▷ LS CAN:

There are two types of wake-up for the LS CANs:

Wake-up by direct BSI input:

For this wake-up, the BSI activates the +CAN and sends wake-up frames on the LS CANs.

Wake-up by indirect BSI input:

ECUs capable of waking up LS CANs have a +BAT.

In this condition, these ECUs can also send frames to ask the BSI to wake up the LS CANs.



Stand-by:

If no wake-up request is activated:

- ▷ The BSI sends a "stand-by" message on the CAN bus.
- ▷ After one minute 15 seconds, the CAN bus switches to stand-by.
- ▷ The ECUs no longer communicate.
- ▷ The BSI switches off the +CAN supply.
- ▷ One minute later, the BSI switches to stand-by.



▪ Various stages of multiplex networks

▪ Wake-up conditions:

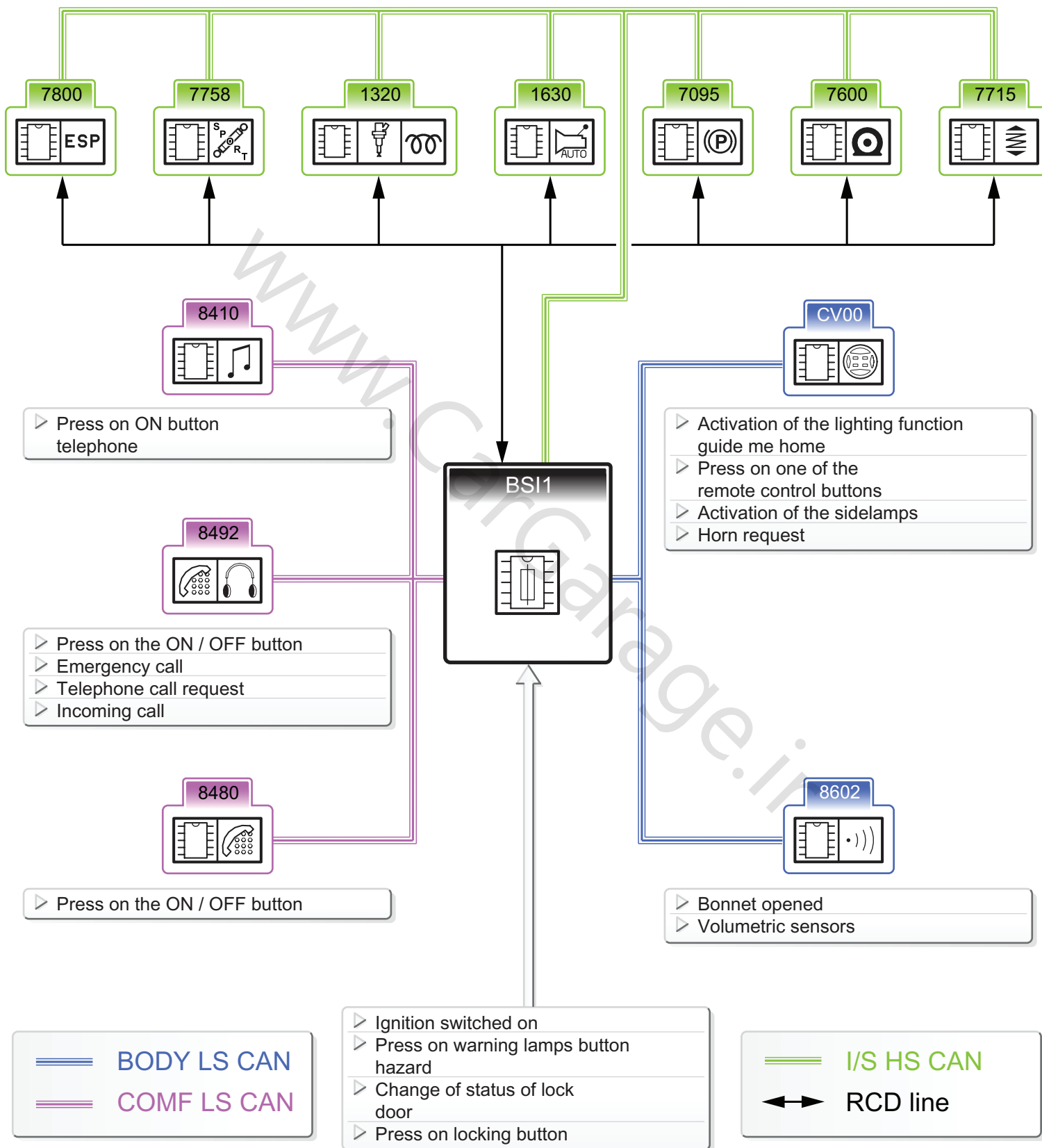

- Network activity during the various phases (average values +/- 0.1 V):

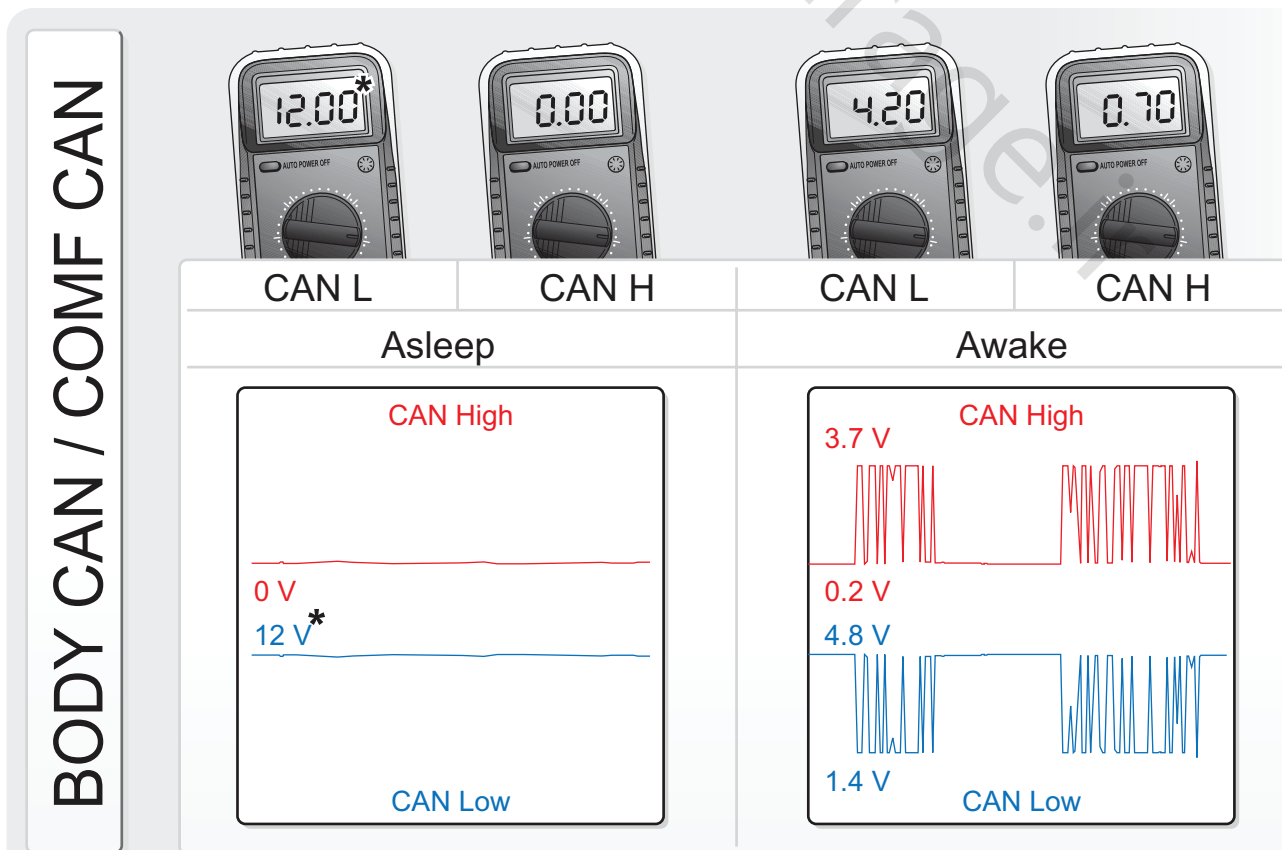
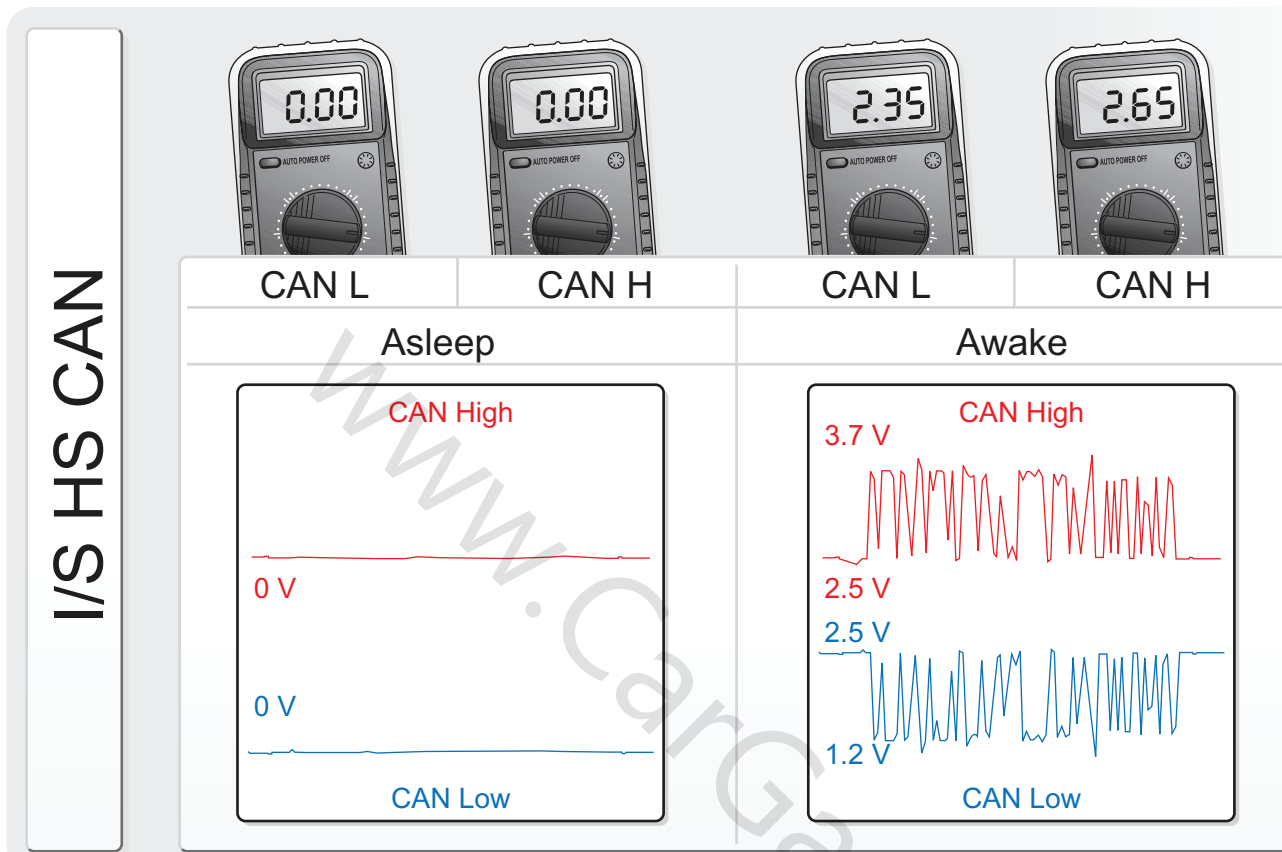

*battery voltage



■ Wiring diagram

■ Battery (BB00):

This is located on the front left hand side, under the bonnet for all engines, except the 2.7 HDI engine where the battery is located on the rear left hand side of the vehicle in the boot, behind the side trim.

■ Wiring diagram:

Electrical distribution and protection is performed by the following components:

From Battery Fuse Box (BFDB) (front battery)

Located under the bonnet behind the LH headlamp, it distributes and protects the supplies of the following electrical components:

- | | |
|---------------------------------|--------------------------|
| ▷ Electric-pump unit | ▷ Trailer Relay Unit |
| ▷ Built-in Hydraulics Interface | ▷ Boot 12 V socket |
| ▷ Pre-post heating unit | ▷ Fog lamps |
| ▷ Engine cooling fan unit | ▷ Additional heater |
| ▷ and switching unit | ▷ Electric parking brake |
| Protection (3 relays) | |

Battery cable protection unit (BPCB) (rear battery)

Located above the battery, it distributes and protects the supplies to the electrical components following:

- ▷ Starter motor
- ▷ Alternator
- ▷ Engine Compartment Relay Plate - Fuse Box
- ▷ Boot 12 V socket
- ▷ Electric parking brake

Front fuse module unit (MFAV) (rear battery)

Located under the bonnet behind the LH headlamp, it distributes and protects the supplies of the following electrical components:

- ▷ Pre-post heating unit
- ▷ Engine cooling fan unit
- ▷ Interference suppressor (capacitor)
- ▷ Protection and switching unit (3 relays)

Engine compartment fuse and relay unit (PSF1)

Located under the bonnet behind the LH headlamp, it distributes and protects the supplies of the electrical components in the engine compartment.

It also supplies the BSI and the two fuse boxes passenger compartment.

Built-in Systems Interface (BSI)

Located under the dashboard on the LH side, it distributes and protects the supplies to the electrical components in the passenger compartment and on the body.

Passenger compartment 5 fuse box (BFH5)

Located on the BSI housing, it distributes and protects the supplies to the following electrical components:

- ▷ AM6 type automatic gearbox
- ▷ AL4 type automatic gearbox
- ▷ Day running lights
- ▷ Diagnostic socket
- ▷ Electronic stability program (ESP) ECU
- ▷ suspension ECU
- ▷ Brake dual function switch

Passenger compartment 12 fuse box (BH12)

Located on the BSI housing, it distributes and protects the supplies to the following electrical components:

- | | |
|-------------------------------|-----------------------------------|
| ▷ Trailer Relay Unit | ▷ Sunroof |
| ▷ JBL amplifier | ▷ Screen |
| ▷ and lighting unit | ▷ Electrochrome rear view mirrors |
| ▷ Passenger's memorising | ▷ not fastened LED display |
| ▷ Electric seat unit | ▷ Seat belt |
| ▷ Heated seats | ▷ Rain and brightness sensor |
| ▷ Motorised tailgate (estate) | ▷ Heated door mirrors |



Wiring diagram

Front battery:

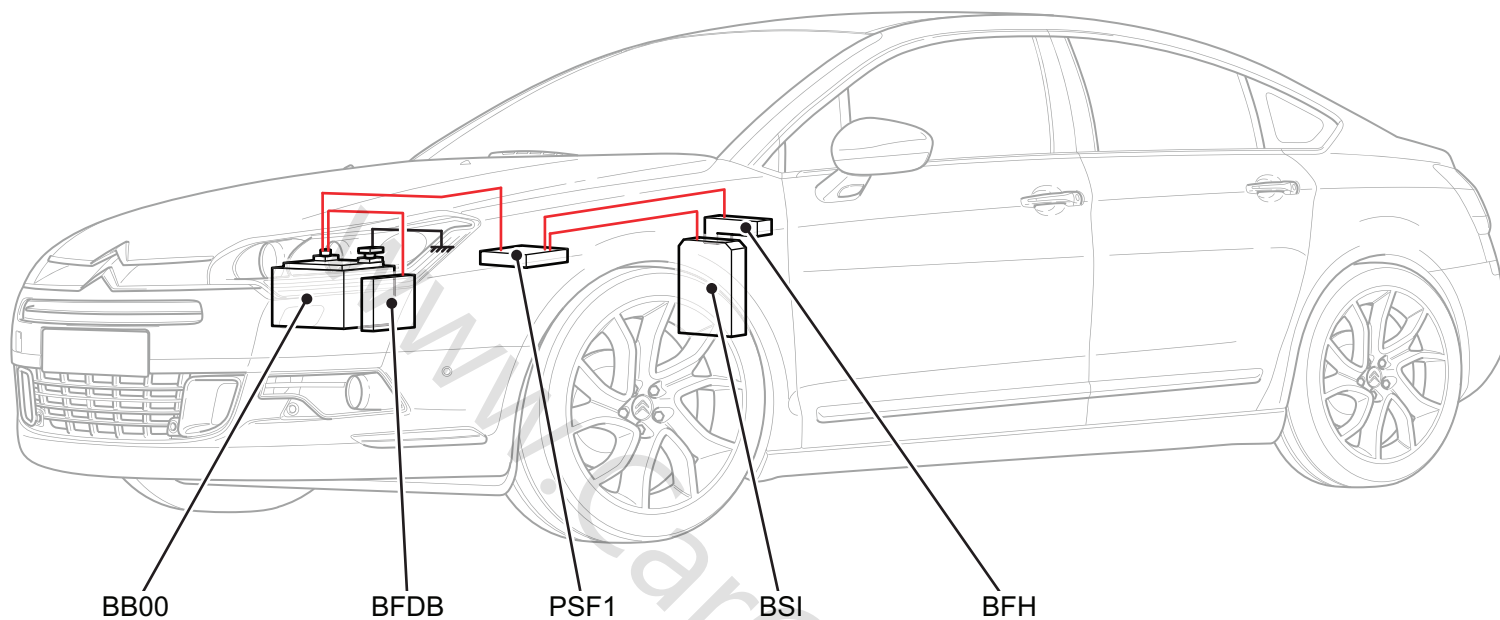



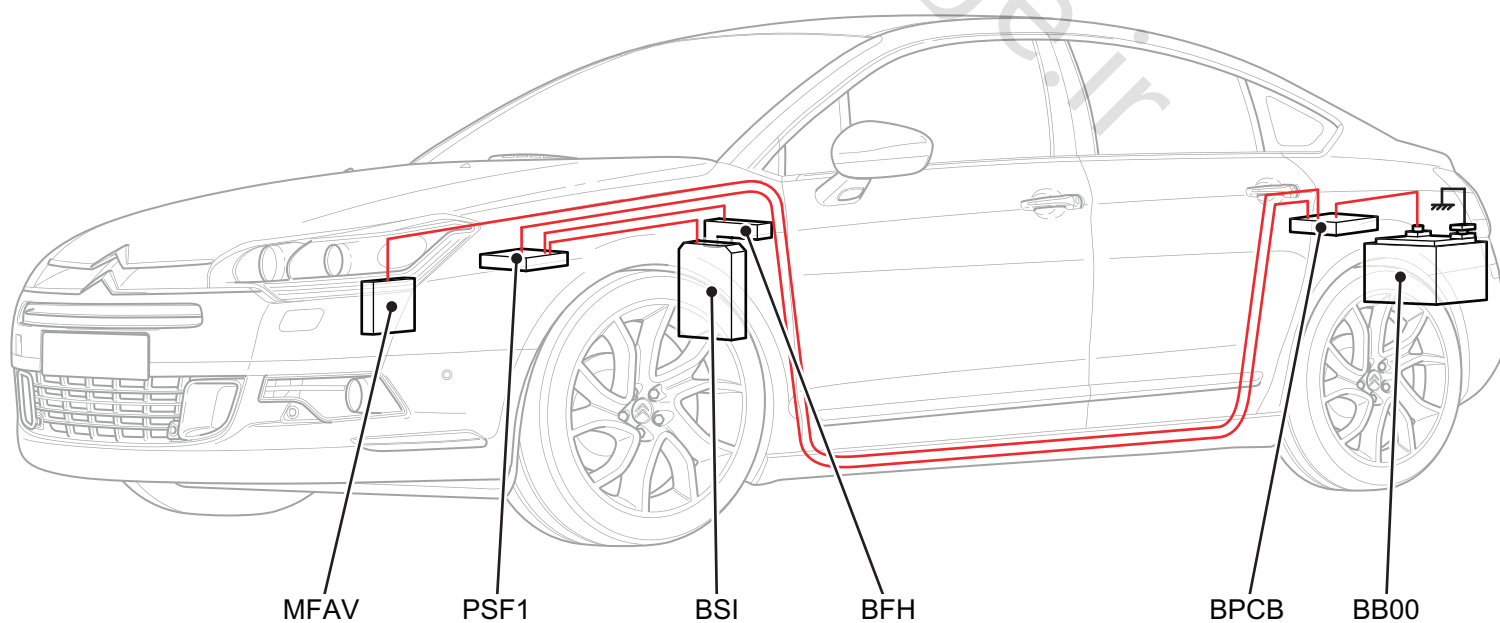



Rear battery:





■ Glossary

Symbol	Abbreviation	Definition
	+BAT	Permanent battery positive supply
	+IGN	Positive after ignition supply
	+RCD	Remote controlled wake-up supply of the HS CAN
	+CAN	LS CAN supply
	+LIN	LIN supply
	LHD	LH drive
	RHD	RH drive



▪ Notes

Lined area for notes with a large diagonal watermark reading 'www.CarGarage.ir'.



▪ Notes

Lined area for notes with a large diagonal watermark reading 'www.CarGarage.ir'.

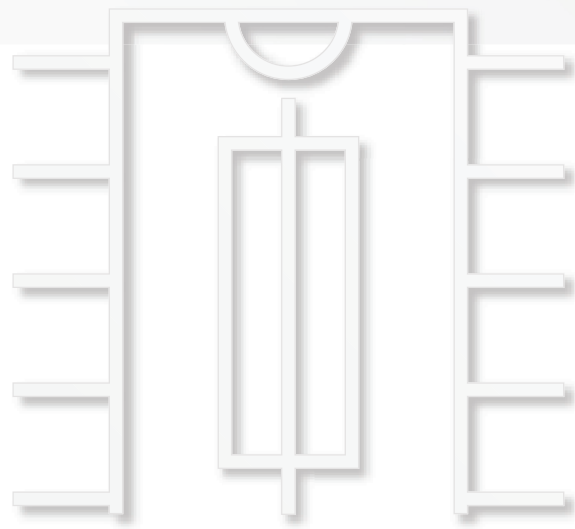
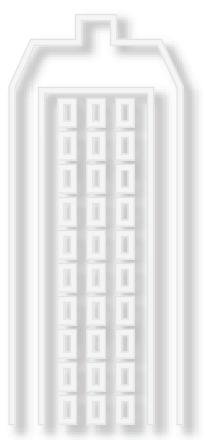
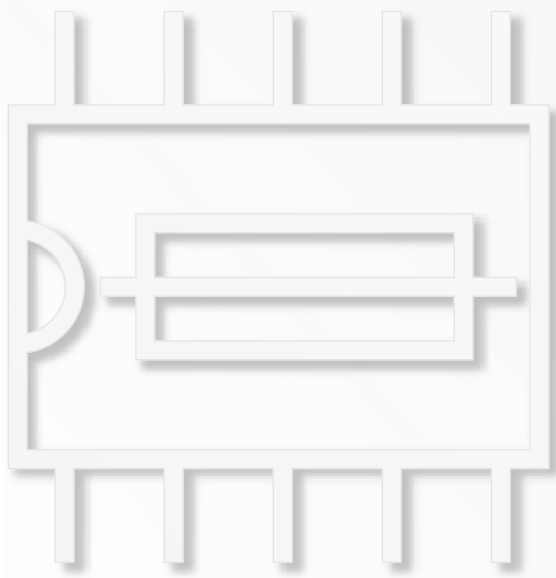
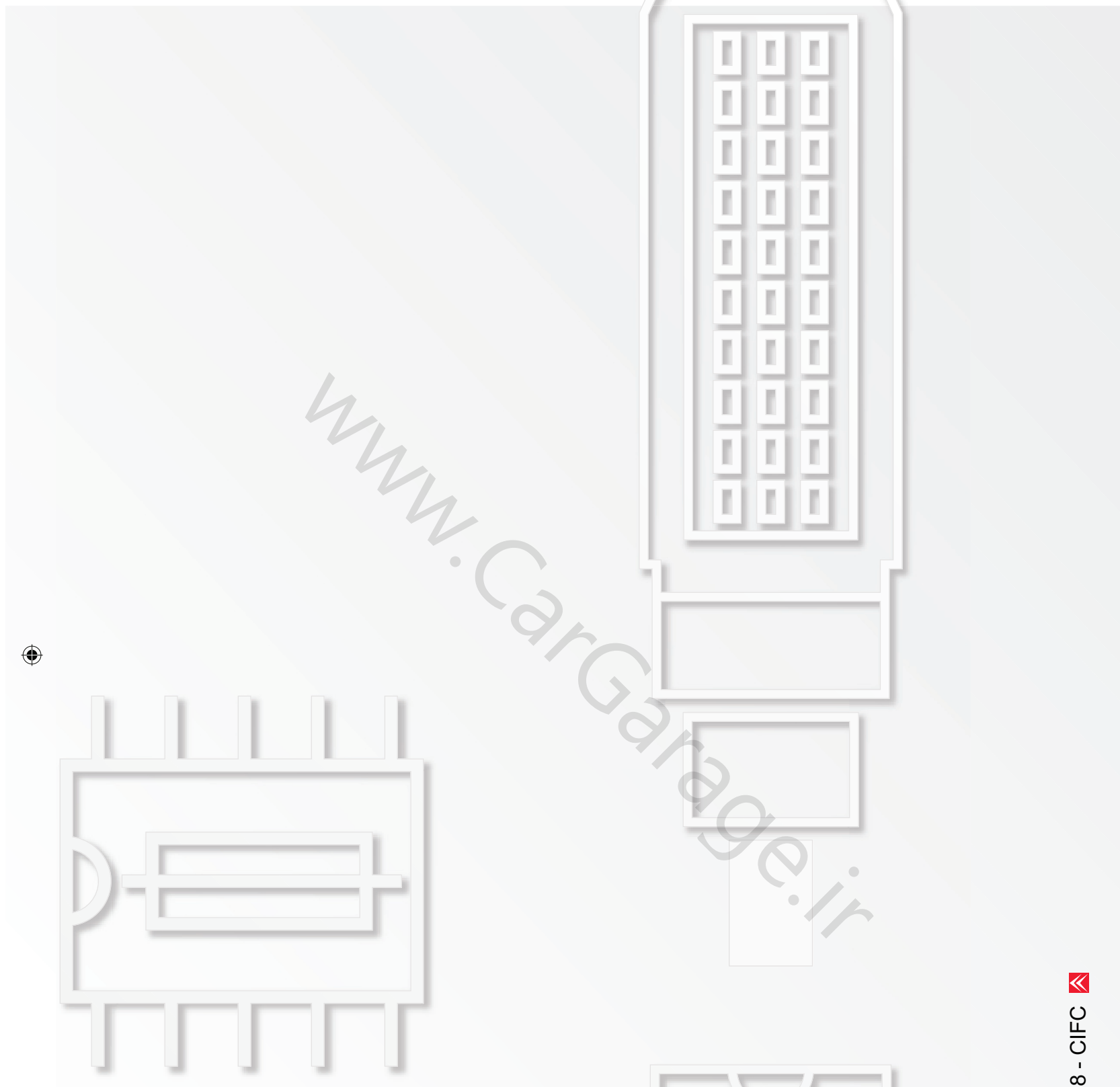

January 2008 - CIFIC